



# ORIENT

## Photo coupler

### Product Data Sheet

Part Number: ORPC-814

Customer: \_\_\_\_\_

Date: \_\_\_\_\_

**SHENZHEN ORIENT COMPONENTS CO., LTD**

Block A 3rd Floor No.4 Building, Tian'an Cyber Park, Huangge Rd, LongGang Dist, Shenzhen, GD

TEL: 0755-29681816

FAX: 0755-29681200

[www.orient-opto.com](http://www.orient-opto.com)

### 1. Features

- (1) AC input response.
- (2) Current transfer ratio ( CTR : MIN. 20% at  $I_F = \pm 1\text{mA}$ ,  $V_{CE} = 5\text{V}$  )
- (3) Wide Operating temperature range  $-55\sim 110^\circ\text{C}$
- (4) High input-output isolation voltage (  $V_{iso} = 5,000\text{Vrms}$  )
- (5) Response time (  $t_r$  : TYP.  $4\mu\text{s}$  at  $V_{CE} = 2\text{V}$ ,  $I_C = 2\text{mA}$ ,  $R_L = 100$  )
- (6) High collector-emitter voltage ( $V_{CE} \cong 80\text{V}$ )
- (7) ESD pass HBM 8000V/MM 2000V
- (8) Safety approval
  - UL approved (No.E323844)
  - VDE approved (No.40029733)
  - CQC approved (No.CQC09001029446)
- (9) In compliance with RoHS, REACH standards
- (10) MSL ClassI



### 2. Description

- (1) The ORPC-814 series of devices each consist of two infrared emitting diodes, connected in inverse parallel, optically coupled to a photo transistor detector.
- (2) They are packaged in a 4-pin DIP package and available in side-lead spacing and SMD option.

### 3. Applications

- (1)AC line monitor
- (2)Programmable controllers
- (3)Telephone line interface
- (4)Unknown polarity DC sensor

### 4. Functional Diagram

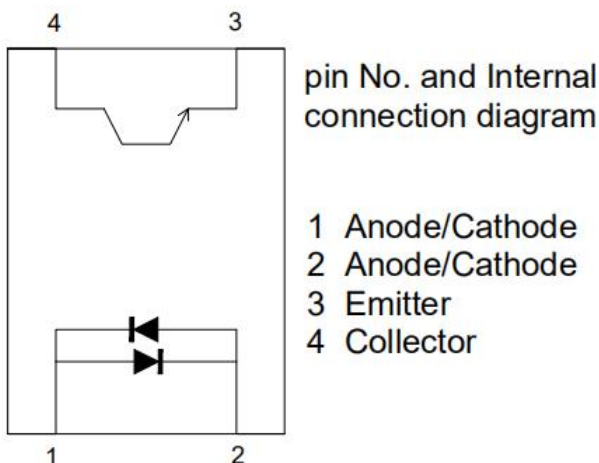

**5. Absolute Maximum Ratings at Ta=25°C**

Parameter		Symbol	Rated Value	Unit
Input	Forward Current	$I_F$	$\pm 50$	mA
	Peak forward Current (100 $\mu$ s pulse, 100Hz frequency)	$I_{FP}$	1	A
	Consume Power	P	70	mW
Output	Collector and emitter Voltage	$V_{CEO}$	80	V
	Emitter and collector Voltage	$V_{ECO}$	7	
	Collector Current	$I_C$	50	mA
	Consume Power	$P_C$	150	mW
Total Power Dissipation		$P_{tot}$	200	mW
*1 Isolation Voltage		$V_{iso}$	5,000	V <sub>rms</sub>
Operating Temperature		$T_{opr}$	-50 to + 110	°C
Storage Temperature		$T_{stg}$	-55 to + 125	
*2 Soldering Temperature		$T_{sol}$	260	

1. AC For 1 Minute, R.H. = 40 ~ 60%

Isolation voltage shall be measured using the following method.

- (1) Short between anode and cathode on the primary side and between collector and emitter on the secondary side.
- (2) The isolation voltage tester with zero-cross circuit shall be used.
- (3) The waveform of applied voltage shall be a sine wave.

2. For 10 Seconds

**6. Electro-Optical Characteristics (Ta=25°C unless specified otherwise)**

Parameter		Symbol	Min	Typ.*	Max	Unit	Condition
<b>Input</b>	Forward Voltage	$V_F$	---	1.2	1.4	V	$I_F=\pm 20\text{mA}$
	Collector Capacitance	$C_t$	---	30	250	pF	$V=0, f=1\text{KHz}$
<b>Output</b>	Collector to Emitter Current	$I_{CEO}$	---	---	100	nA	$V_{CE}=20\text{V}, I_F=0\text{mA}$
	Collector and Emitter attenuation Voltage	$BV_{CEO}$	80	---	---	V	$I_C=0.1\text{mA}, I_F=0\text{mA}$
	Emitter and Collector attenuation Voltage	$BV_{ECO}$	7	---	---	V	$I_E=0.1\text{mA}, I_F=0\text{mA}$
<b>Transforming Characteristics</b>	*1 Current conversion ratio	CTR	20	---	300	%	$I_F=\pm 1\text{mA}, V_{CE}=5\text{V}$
	Collector Current	$I_C$	0.2	---	3	mA	
	Collector and Emitter Saturation Voltage	$V_{CE(sat)}$	---	0.1	0.2	V	$I_F=\pm 20\text{mA}, I_C=1\text{mA}$
	Insulation Impedance	$R_{iso}$	$5 \times 10^{10}$	$1 \times 10^{12}$	---	$\Omega$	DC500V 40~60%R.H.
	Floating Capacitance	$C_f$	---	0.6	1.0	pF	$V=0, f=1\text{MHz}$
	Cut-off Frequency	$f_c$	---	80	---	kHz	$V_{CE}=5\text{V}, I_C=2\text{mA}, R_L=100\Omega, -3\text{dB}$
	Rise Time	$t_r$	---	4	18	$\mu\text{s}$	$V_{CE}=2\text{V}, I_C=2\text{mA}, R_L=100\Omega$
	Descend Time	$t_f$	---	3	18	$\mu\text{s}$	

\*1 Current Conversion Ratio =  $I_C / I_F \times 100\%$ , CTR Tolerance:  $\pm 3\%$ .

**7. Rank Table of Current Transfer Ratio**

	CTR Rank	Min	Max	Condition	Unit
ORPC-814	A	50	150	$I_F = \pm 1\text{mA}$ $V_{CE} = 5\text{V}$ $T_a = 25\text{ }^\circ\text{C}$	%
	B	100	300		
	C	100	200		
	No mark	20	300		

**8. Order Information**

Part Number

**ORPC-814XT-V-W-Y-Z**

Note

X = Lead form option (S, M or none)

T = CTR Rank (A, B, C or none)

V = Tape and reel option (TP, TP1 or none).

W = Lead frame option (F: Iron, C:copper)

Z = 'G' code for Halogen free (This options is not necessary).

\* Halogen Free can be selected.

Option	Description	Packing quantity
None	Standard DIP-4	100 units per tube
M	Wide lead bend (0.4 inch spacing)	100 units per tube
S(TP)	Surface mount lead form (low profile) + TP tape & reel option	2000 units per reel
S(TP1)	Surface mount lead form (low profile) + TP1 tape & reel option	2000 units per reel

## 9. Naming Rule

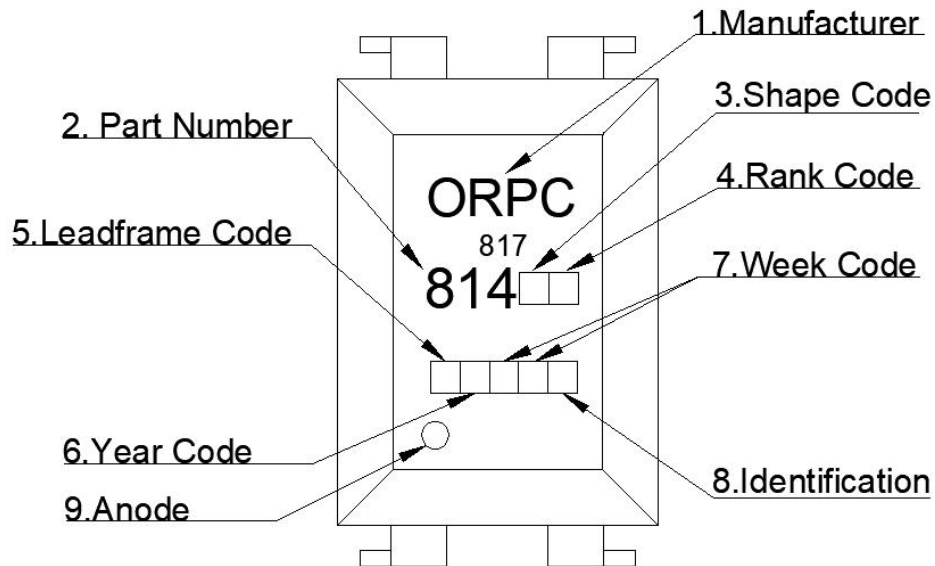

1. Manufacturer : ORIENT.
2. Part Number : 814.
3. Shape Code .
4. Rank Code : CTR Rank
5. Lead frame Code : 'F' means Iron, 'C' means Copper.
6. Year Code  : '1' means '2021' and so on.
7. Week Code : 01 means the first week, 02 means the second week and so on.
8. Identification .
9. Anode.

\* Halogen Free Mark can be selected.

10. Package Dimension (Unit: mm)

1. ORPC-814

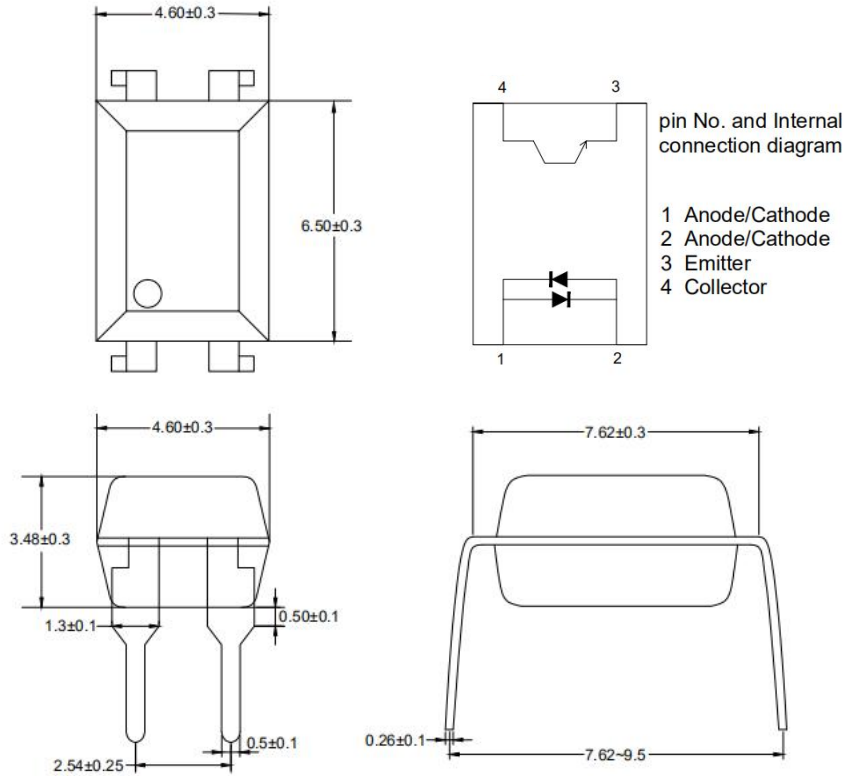

2. ORPC-814M

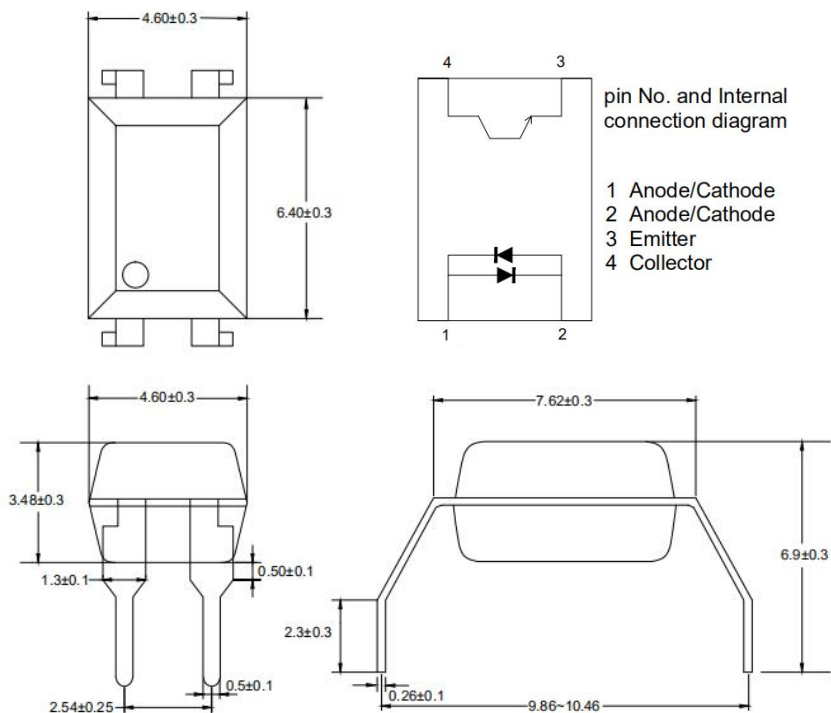

3. ORPC-814S

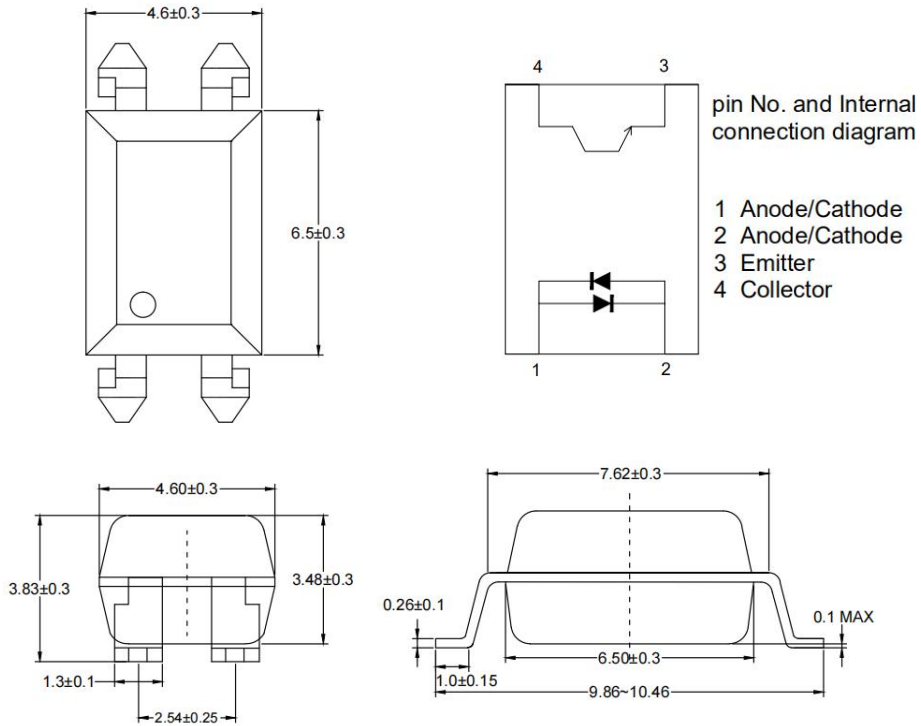

11. Taping Dimensions

(1) ORPC-814S-TP

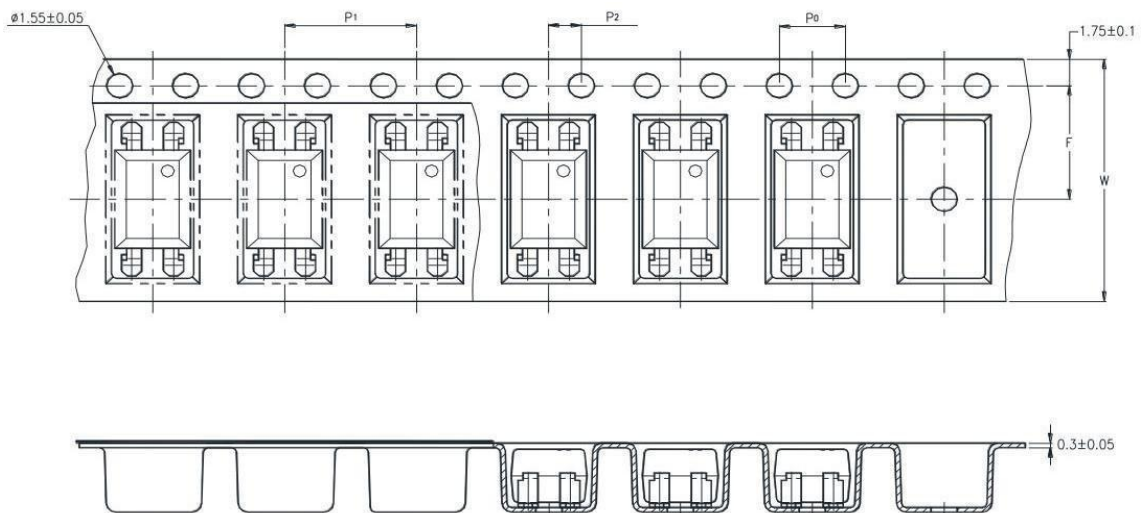



(2)ORPC-814S-TP1

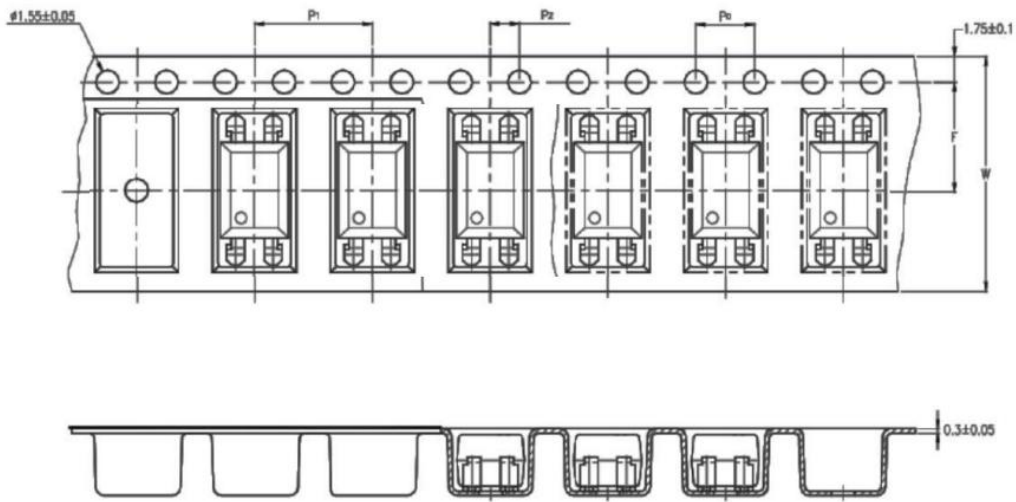

Description	Symbol	Dimension in mm (inch)
Tape wide	W	16±0.3 (.63)
Pitch of sprocket holes	$P_0$	4±0.1 (.15)
Distance of compartment	F	7.5±0.1 (.295)
	$P_2$	2±0.1 (.0079)
Distance of compartment to compartment	$P_1$	8±0.1 (.472)

Package Type	TP/TP1
Quantities(pcs)	2000

12. Recommended Foot Print Patterns (Mount Pad) (Unit: mm)

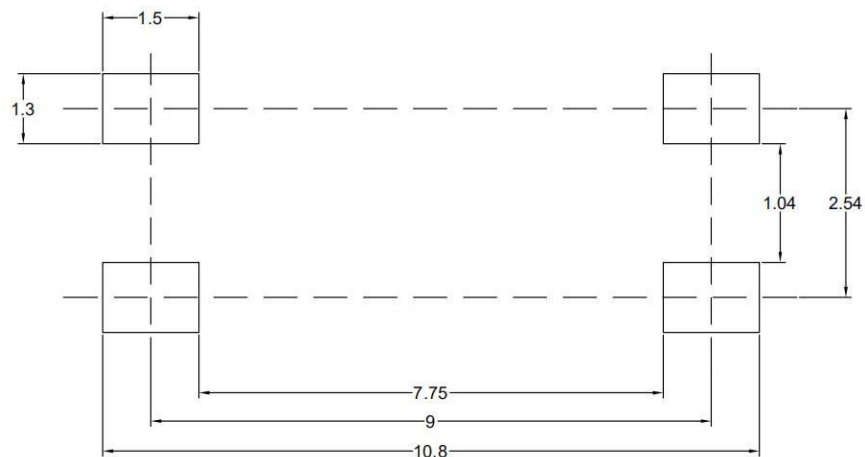

### 13. Package Dimension

#### (1) package dimension

DIP Type

Packing Information	
Packing type	Tube
Qty per Tube	100pcs
Small box (Inner) Dimension	525*128*60mm
Large box (Outer) Dimension	545*290*335mm
The Amount per Inner Box	5,000pcs
The Amount per Outer Box	50,000pcs



SOP Type

Packing Information	
Packing type	Reel type
Tape Width	16mm
Qty per Reel	2,000pcs
Small box (inner) Dimension	345*345*58.5mm
Large box (Outer) Dimension	620x360x360mm
Max qty per small box	4,000pcs
Max qty per large box	40,000pcs

#### (2)Packing Label Sample



Material Code : 120PCXXXXXX  
  
P/N: OR-XXXXXX  
  
Lot No. : XXXXXX-XXXXX-TX-X  
  
D/C : XXXX  
  
Qty : XXXX PCS  

内箱码

外箱码

“XXXXXXXXXXXXXXXXXX” (一体机序列码)  
**Made in China**

**Note:**

1. Material Code :Product ID.
2. P/N :Contents with "Order Information" in the specification.
3. Lot No. :Product data.
4. D/C :Product weeks.
5. Quantity :Packaging quantity.

14. Reliability Test

NO.	ITEMS	Reliability Testing				
		QTY. (Pcs)	Condition	Process	Device	Standard
1	RSH 耐焊接热	22	260±5℃	10s/3 次	锡炉	JESD22-A106
2	HTSL 高温存储	77	125℃	168 hrs	高温烤箱 测试仪	JESD22-A103
				500 hrs		
				1000 hrs		
3	LTSL 低温存储	77	-55℃	168 hrs	低温箱 测试仪	JESD22-A119
				500 hrs		
				1000 hrs		
4	TC 温度循环	77	H:125℃ 15min ∫ 5min L:-55℃ 15min	300 cycle	冷热冲击机	JESD22-A104
5	TS 温度冲击	77	H:100℃ 5min ∫ 15s L:-40℃ 5min	300 cycle	冷热冲击机	JESD22-A106
6	HTOL 高温操作	77	110℃ IF=10mA Vce=5V	168 hrs	高温烤箱 测试仪、老 化电路板	JESD22-A108
				500 hrs		
				1000 hrs		
7	ESD-HBM 人体模式	22	≥8KV 1Cycle	1次	ESD静电测 试仪	JESD22-A114
8	SD 可焊性	22	Pb-free 245±5℃	5S/1次	锡炉	JESD22-B102
9	HTRB 高温反向偏压	77	HTRB @125℃ Vce=80v	168 hrs	高温烤箱 , 测试仪	JESD22-A103
				500 hrs		
				1000 hrs		
10	H3TRB 温湿度反向偏 压, 寿命试验	77	H3TRB 85℃,85%RH Vce=80v	168 hrs	恒温恒湿 机, 测试仪	JESD22-A101
				500 hrs		
				1000 hrs		
11	Autoclave 压力锅	77	Ta=121 ℃,100%RH,2atm	96hrs	压力锅	JESD22-A102

**15. Temperature Profile Of Soldering**

**(1).IR Reflow soldering (JEDEC-STD-020C compliant)**

One time soldering reflow is recommended within the condition of temperature and time profile shown below. Do not solder more than three times.

Profile item	Conditions
Preheat	
- Temperature Min (T Smin )	150°C
- Temperature Max (T Smax )	200°C
- Time (min to max) (ts)	90±30 sec
Soldering zone	
- Temperature (TL )	217°C
- Time (t L )	60 sec
Peak Temperature	260°C
Peak Temperature time	20 sec
Ramp-up rate	3°C / sec max.
Ramp-down rate from peak temperature	3~6°C / sec
Reflow times	≤3

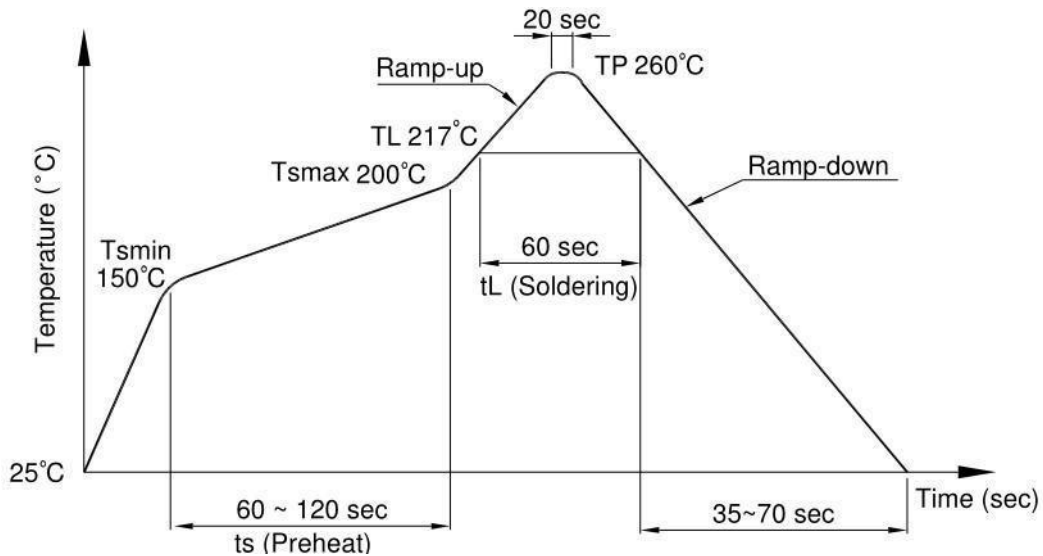

**(2).Wave soldering (JEDEC22A111 compliant)**

One time soldering is recommended within the condition of temperature.

Temperature	260+0/-5°C
Time	10 sec
Preheat temperature	25 to 140°C
Preheat time	30 to 80 sec

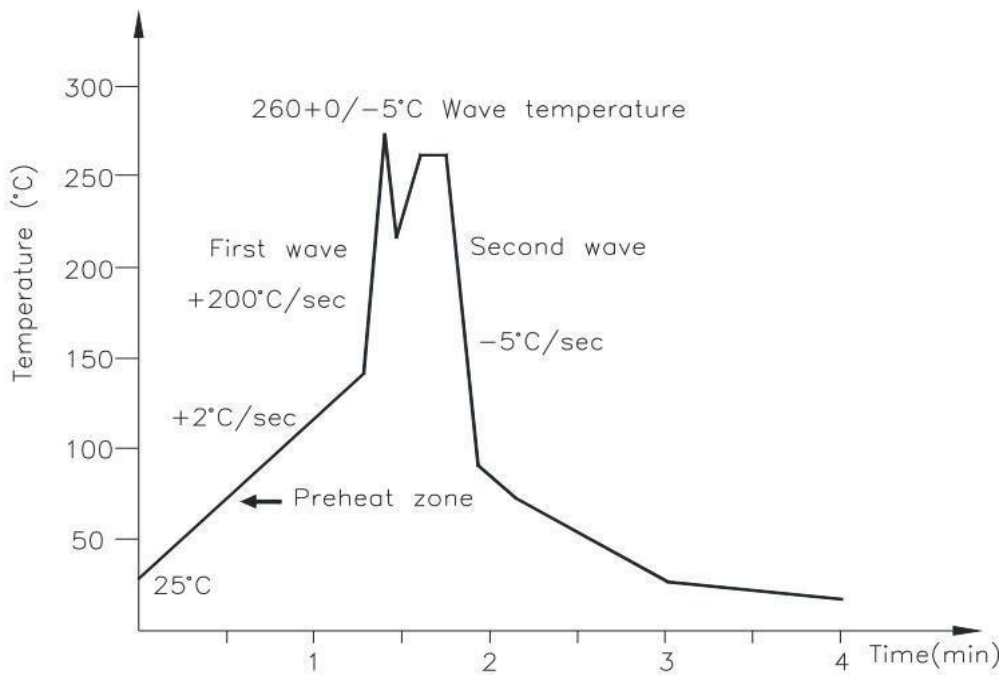

**(3).Hand soldering by soldering iron**

Allow single lead soldering in every single process. One time soldering is recommended.

Temperature	380+0/-5°C
Time	3 sec max

16. Characteristics Curves

Fig.1 Forward current vs Ambient temperature

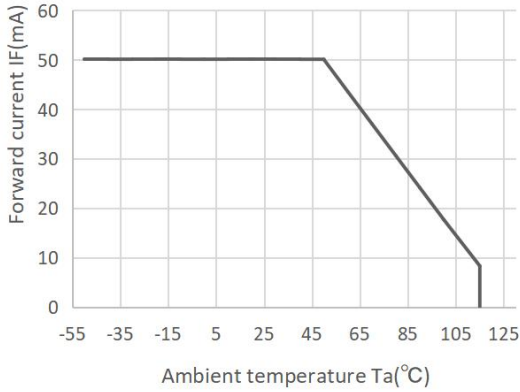

Fig.2 Collector Power Dissipation vs. Ambient temperature

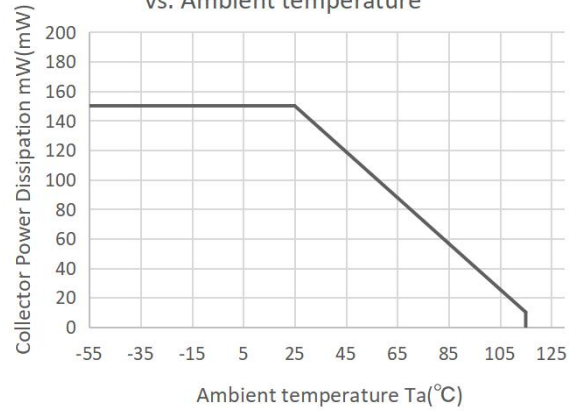

Fig.3 Collector-emitter Saturation Voltage vs. Forward Current

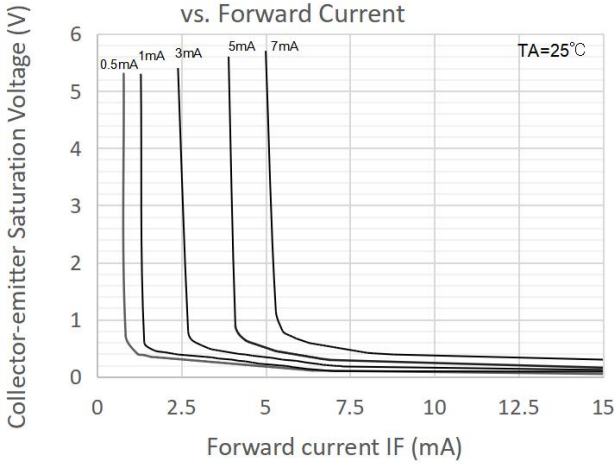

Fig.4 Forward Current vs. Forward Voltage

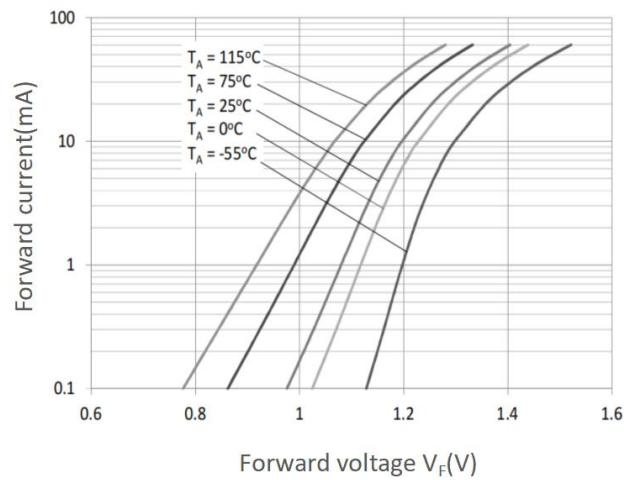

Fig.5 Forward Current vs. Current Transfer Ratio

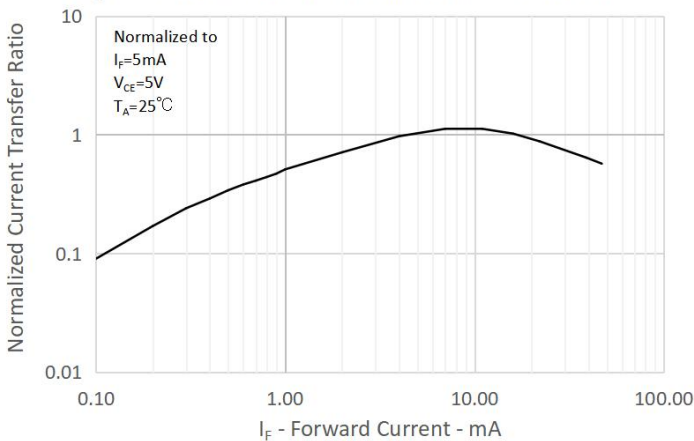

Fig.6 Collector Current vs. Collector-emitter Voltage

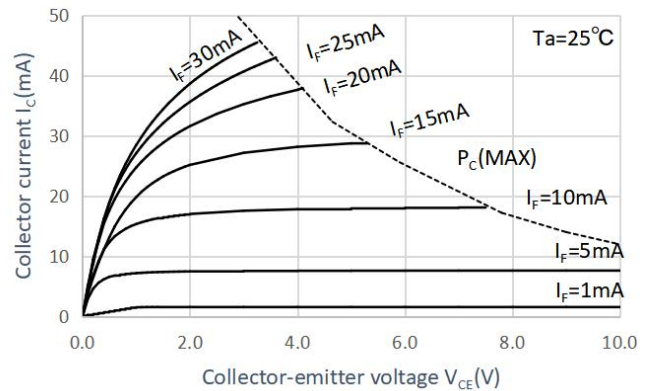

Fig.7 Relative Current Transfer Ratio vs. Ambient Temperature

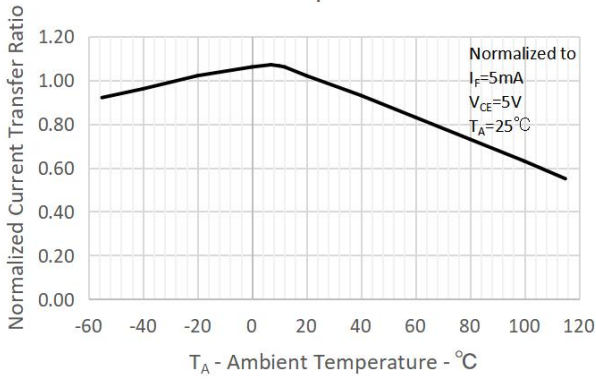

Fig.8 Collector-emitter Saturation Voltage vs. Ambient Temperature

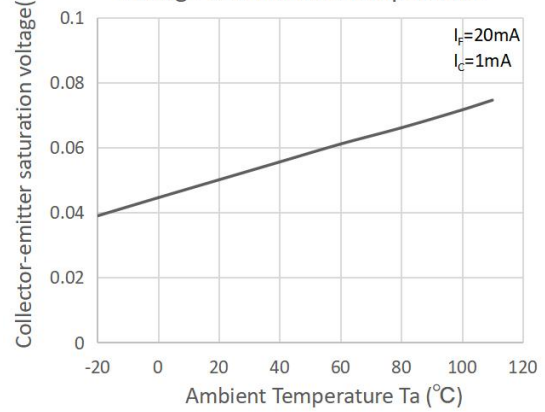

Fig.9 Collector Dark Current vs. Ambient Temperature

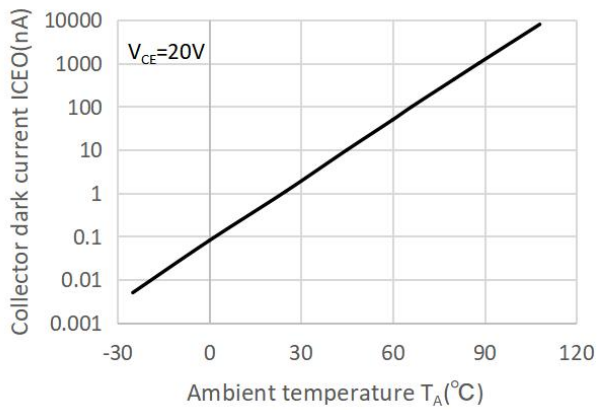

Fig.10 Respinse Time vs. Load Resistance

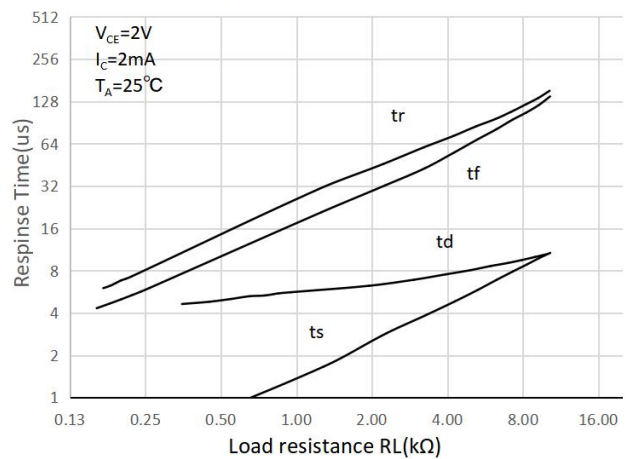
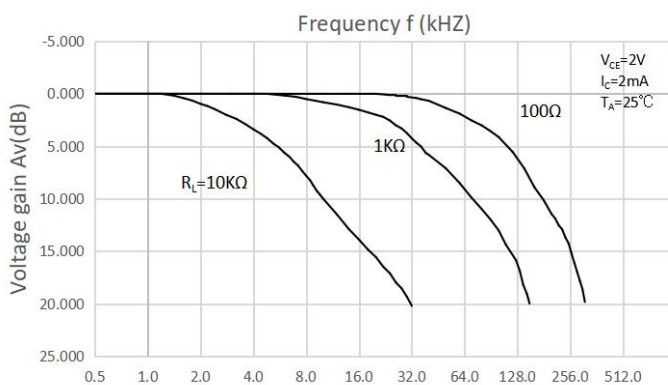
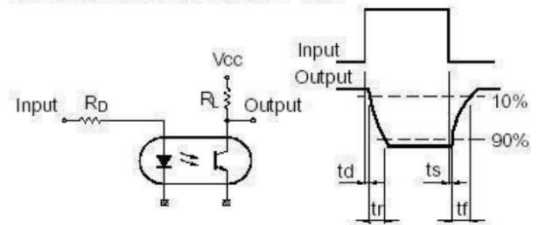

Fig.11 Frequency Response



Test Circuit for Response Time



Test Circuit for Frequency Response

